

钟振DIP14-45.000MHZ

Features

- voltage(1.8V~5.0V)
- Output Waveform(cmos)
- Supports a WIDE FREQUENCY RANGE(20K to 800MHZ)
- Output Voltage:0.4~2.4VDC
- Compact with dimensions of 20.3×12.5×7.0mm



Specifications

项目Item	技术Specifications	
输出波形 Output Waveform	方波 (cmos)	
频率范围Freq. Range	45.000MHZ	
频率稳定性Frequency Stability	±10PPm, ±20PPm, ±30PPm, ±50PPm	
工作温度Operaing Temp	-20°C to 70°C (-40°C to 85°C available)	
储存温度Storage Temp	-55°C to 125°C	
输出波形对称性 Output Symmetry	40-60%@1.4VDC (45-55% available)	
电压Input Voltage:VDD	+5.0Vdc ±5% or +3.3Vdc ±5% available	
电流Input Current:IDD	100KHz to 70MHz, ≤20mA	
	70MHz to 200MHz, ≤40mA	
	≥200.00MHz, ≤60mA	
上升时间Rise Time	TR	≤6ns
下降时间Fall Time	TF	≤6ns
输出电压Output Voltage	VOL	0.4Vdc Max.
	VOH	2.4Vdc Min.
输出负载Output Load	10LSTTL	
起动时间Start up Time	<10ms	
老化能力 Agek Resistance	±3PPm Max	

Ordering Information



输出波形图

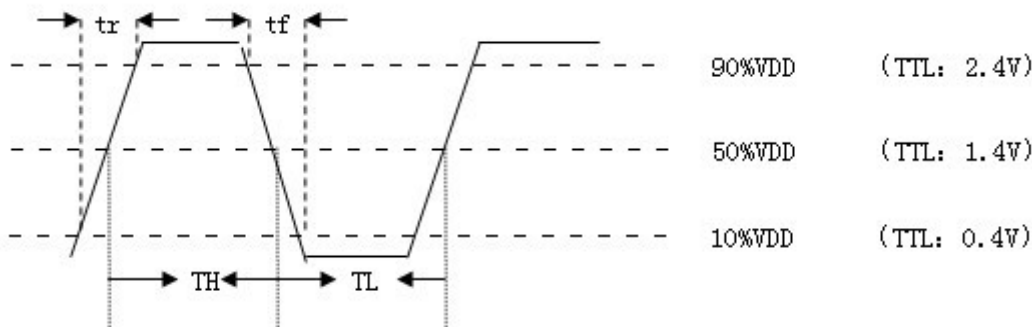

Dimensions



管脚功能

- 1: VC/NC
- 7: GND
- 8: OUT
- 14: VCC (+5.0 VDC)

测试电路图

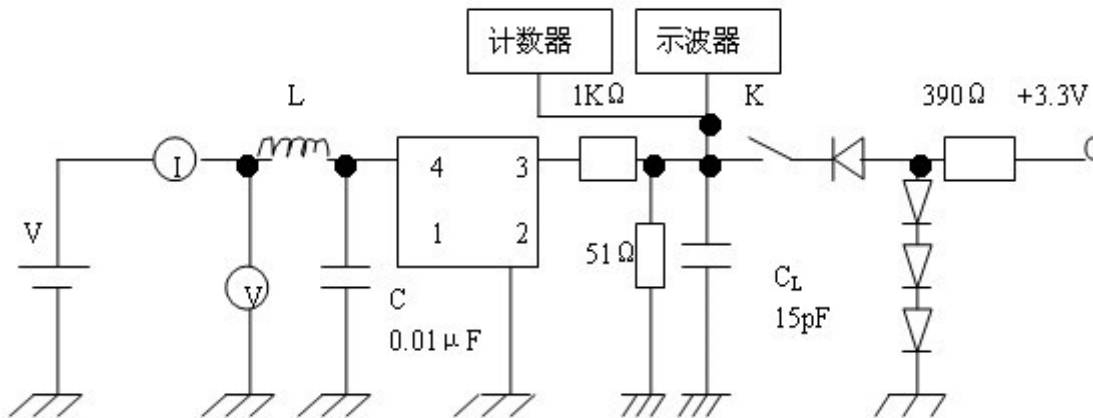

使用电路图和引出端功能说明

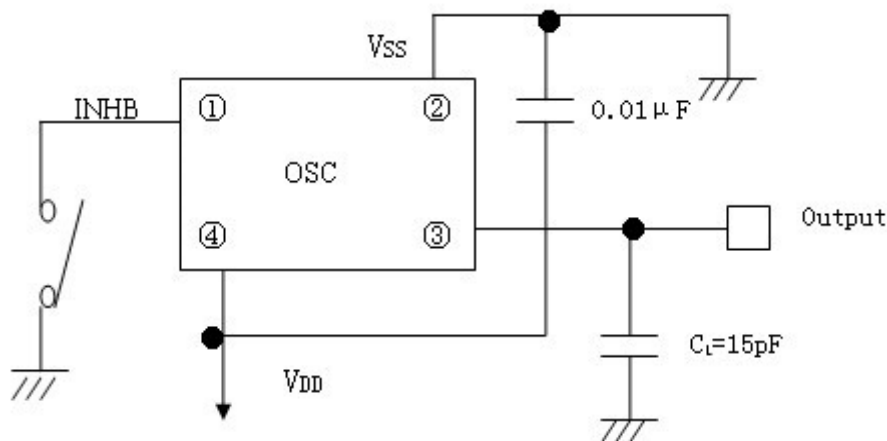

引脚	1	2
功能	输出状态控制/NC	地VSS
引脚	3	4
功能	输出QOUT	电源VDD
输出控制端 INHB	“H”高电平或开路OPEN	“L”低电平（三态）
输出Qout	振荡器正常输出	高阻抗
注意：输出状态控制端INHB（三态端）不能接地，否则振荡器呈高阻抗		