

SMD32254P

■ Features

A small surface-mount type crystal unit, ideal for OA, AV and Accessories for a car, which need performance for wide temperature range.

- Compact and thin. (3.2×2.5×0.7mm typ.)
- Excellent electrical performance, ideal for OA and AV applications.
- Excellent environmental performance, including heat and shock resistance.
- Meets the requirements for re-flow profiling using lead-free solder.

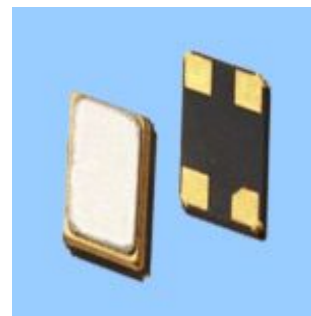

■ Specifications

项目Item	技术Specifications
频率范围Freq. Range	27.000MHZ
调整频差Freq. Tol.	±10PPm to ±100PPm
负载电容Load Capacitance	Suggested by customer
Series Resistance	As ESR table
Storage Temperature	±10PPm to ±100PPm
工作温度Operaing Temp	-10°C to 60°C to -40°C to 85°C
储存温度Storage Temp	-40°C to 85°C to -55°C to 125°C
最大值Max, drive level	1000 μW
建议使用Rec, drive level	10 μW Typical
静电容 Shunt Capacitance	7pF Max
绝缘电阻 Insulation Resistance	500mΩ Min at D.C 100V
老化率Aging	±5PPm/Year Max

■ ESR (Series Resistance)

Frequency (MHz)	Mode	Ohm Max
12.000~16.000MHZ	Fundamental	100
16.000~20.000MHZ	Fundamental	80
20.000~24.000MHZ	Fundamental	60
24.000~50.000MHZ	Fundamental	40

■ Ordering Information

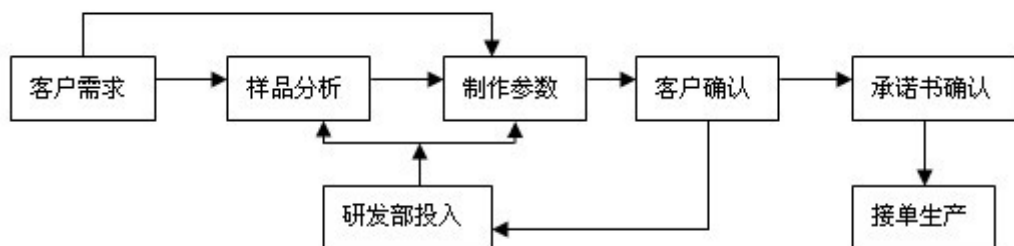

■ Dimensions

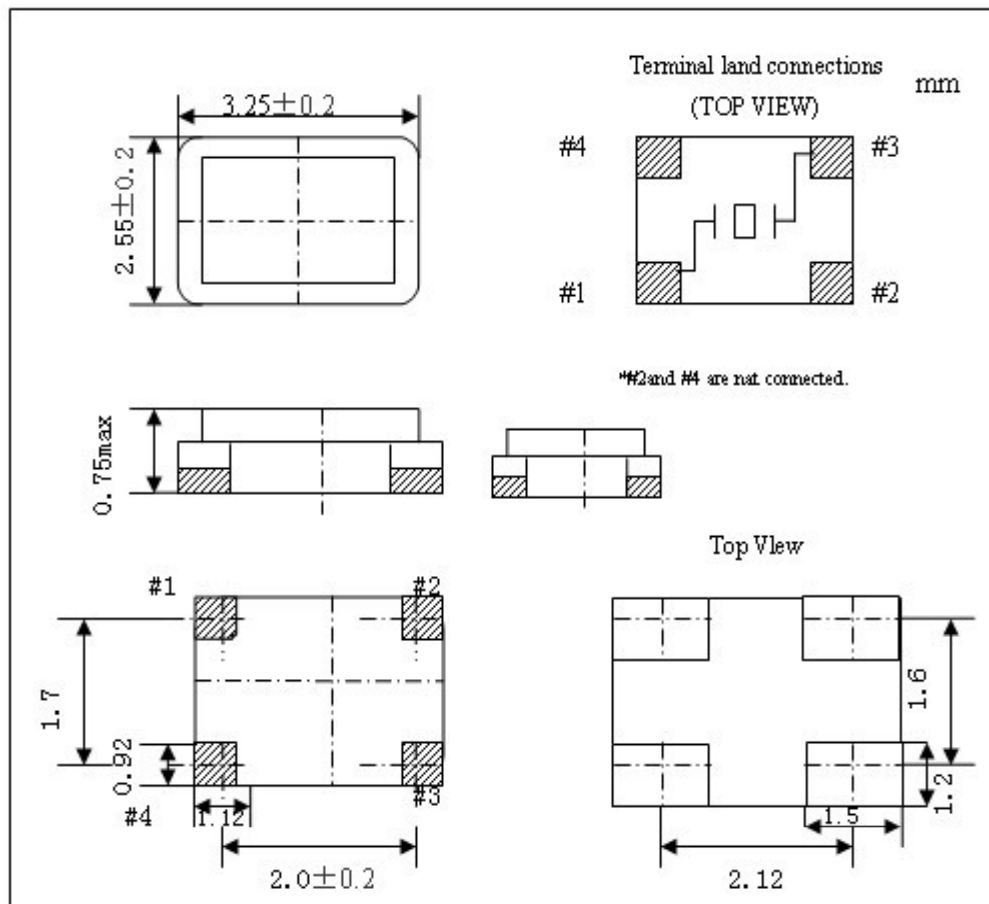

■ Reflow Condition (example)

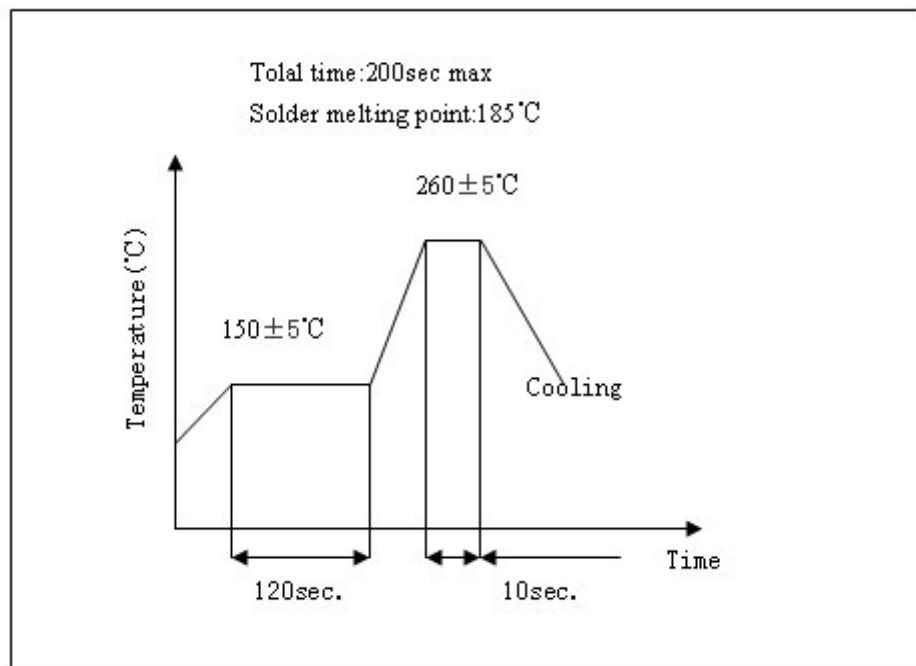

■ Taping Specification

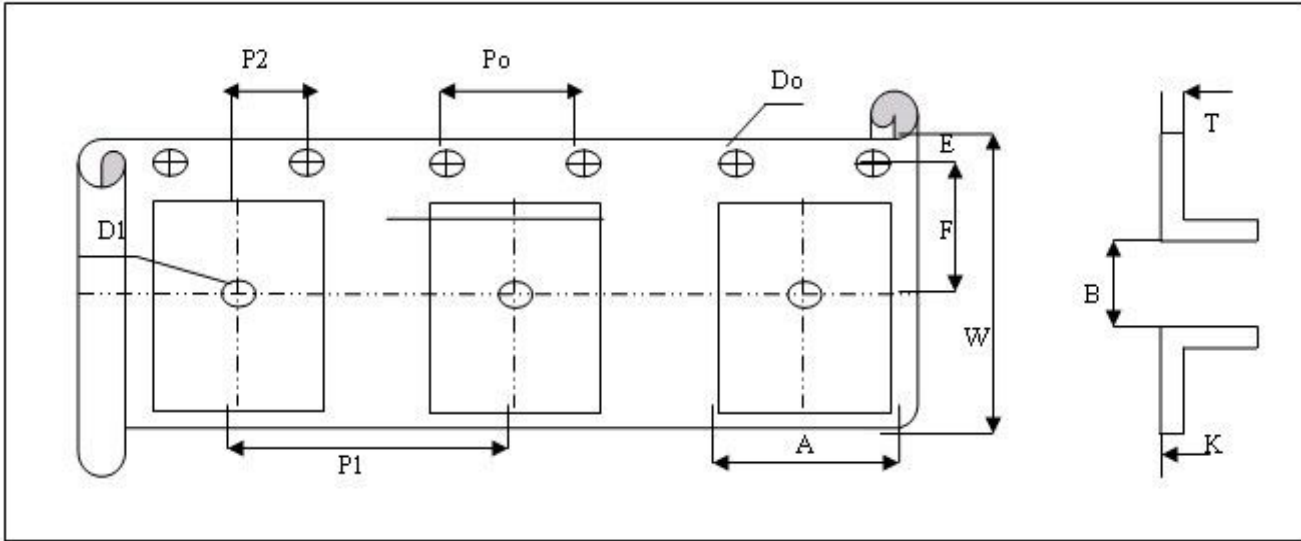

Symbol	A	B	Do	D1	E	F	
DIMENSION	3.2*2.5	2.8	3.5	1.5	1	1.75	3.5
Symbol	K	Po	P1	P2	T	W	
DIMENSION	3.2*2.5	1	4	8	2	0.25	8

Unit:mm

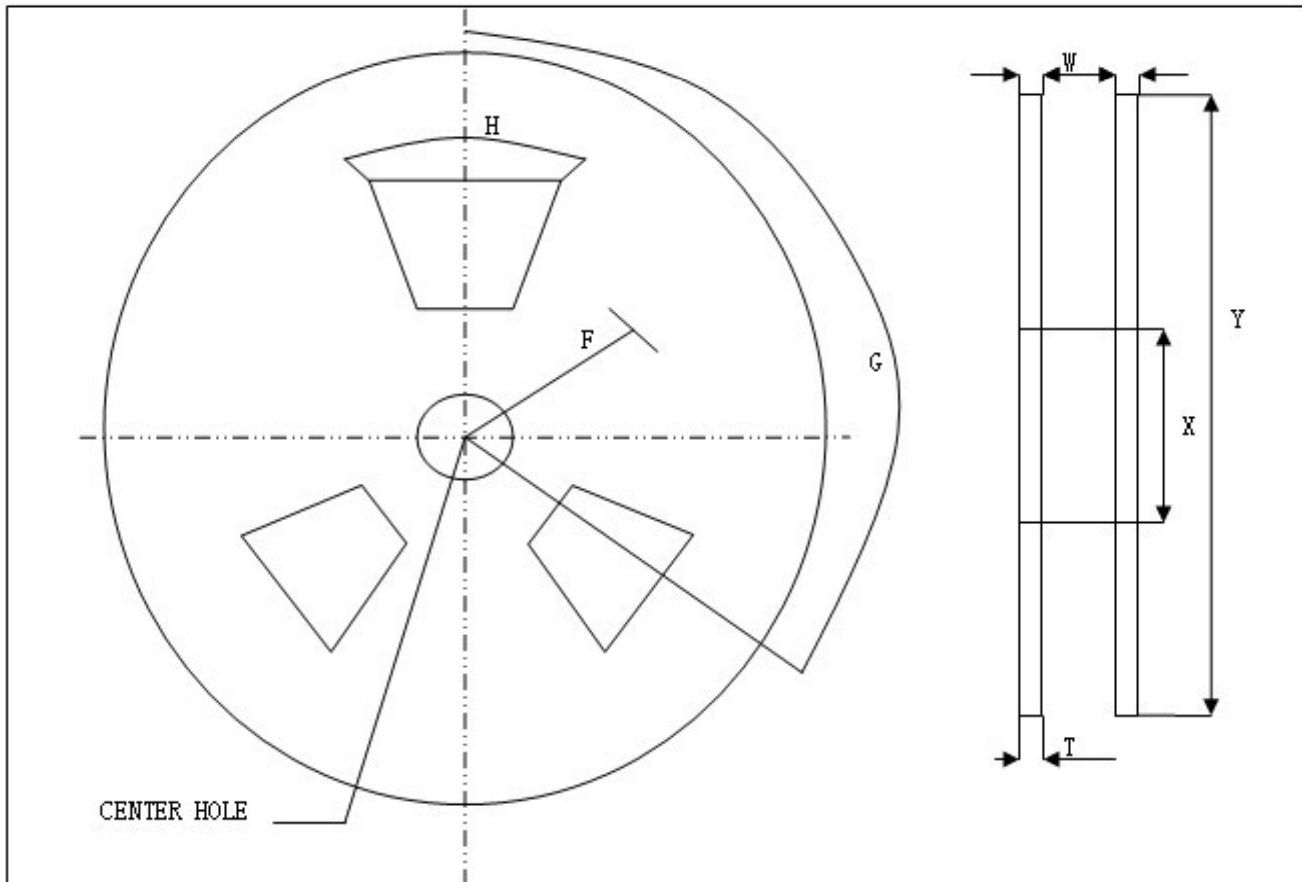

Symbol	H	F	G	W	T	X	Y	
Dimension	3.2*2.5	40°	21±0.8	120	17.5	2	50	250